

WALL STORAGE

DESIGN
DYNAMOBEL

dynamobel

WALL STORAGE

Our offices speak about our companies and express their essence through each detail. Wall Storage is a filing and storage system totally integrated, both technically and aesthetically, with Movinord 82 and 92 partitions. This means that it can come in the same qualities and surface finishes as the partitions you choose.

It can be installed against a wall or integrated into a glazed partition, dividing the space into different atmospheres.

A wide range of file drawers, drawers and easy-to-adjust shelves are available with Wall Storage, as are different horizontal and vertical configurations to suit each project.

TABIQUE ARMARIO
Nuestras oficinas hablan de nuestra empresa y transmiten su esencia a través de cada detalle. El Tabique Armario es un sistema de archivo y almacenamiento totalmente integrado técnica y estéticamente con las particiones Movinord 82 y 92. De esta manera, podemos configurarlo con las mismas calidades y acabados de las particiones que elijamos.

Se instala enfrentado contra la pared o integrado en una partición de cristal, dividiendo el espacio en diferentes ambientes.

El Tabique Armario ofrece una amplia gama de carpeteros, cajoneras y baldas fácilmente regulables, y diferentes configuraciones horizontales y verticales adecuadas para cada proyecto.

TRENNWAND MIT SCHRANK
Unsere Büros sind das Spiegelbild unseres Unternehmens und vermitteln mit jedem Detail sein wahres Wesen. Die Trennwand mit Schrank ist ein technisch und ästhetisch vollständig in die Trennwandsysteme M82 und M92 integriertes Archiv- und Aufbewahrungssystem. Deshalb ist sie mit denselben Qualitäten und Oberflächenausführungen der von Ihnen gewählten Trennwandsysteme frei kombinierbar.

Sie kann direkt gegen die Wand installiert oder in eine Glastrennwand integriert werden und unterteilt den Raum in verschiedene Bereiche.

Die Trennwand mit Schrank stellt eine breite Auswahl an Hängemappenauszügen, Schubladen und einfach verstellbaren Regalen zur Verfügung, so dass ihre horizontale und vertikale Zusammensetzung optimal an jedes einzelne Projekt angepasst werden kann.

WALL STORAGE
TABIQUE ARMARIO
TRENNWAND MIT SCHRANK

INTEGRATED WALL STORAGE
TABIQUE ARMARIO INTEGRADO
INTEGRIERTE TRENNWAND MIT SCHRANK

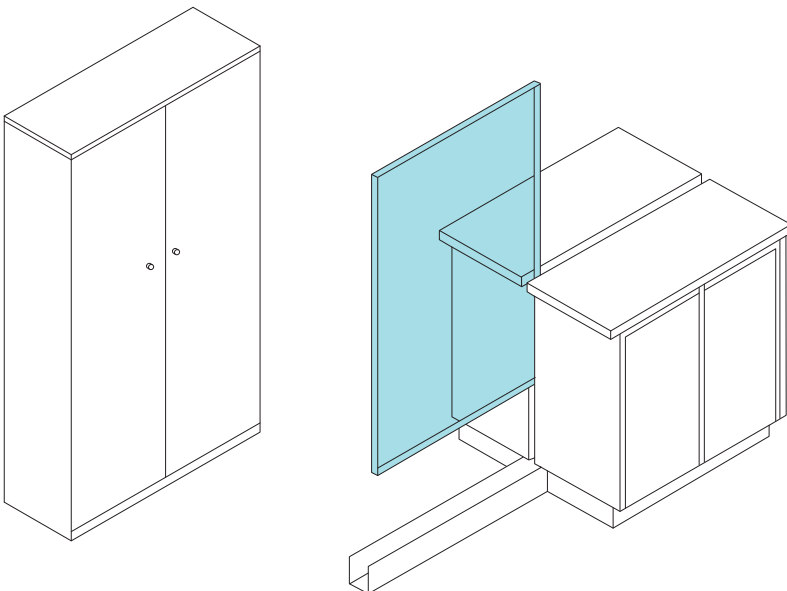



- ▼ **Wall Storage.**
Tabique Armario.
Trennwand mit Schrank.

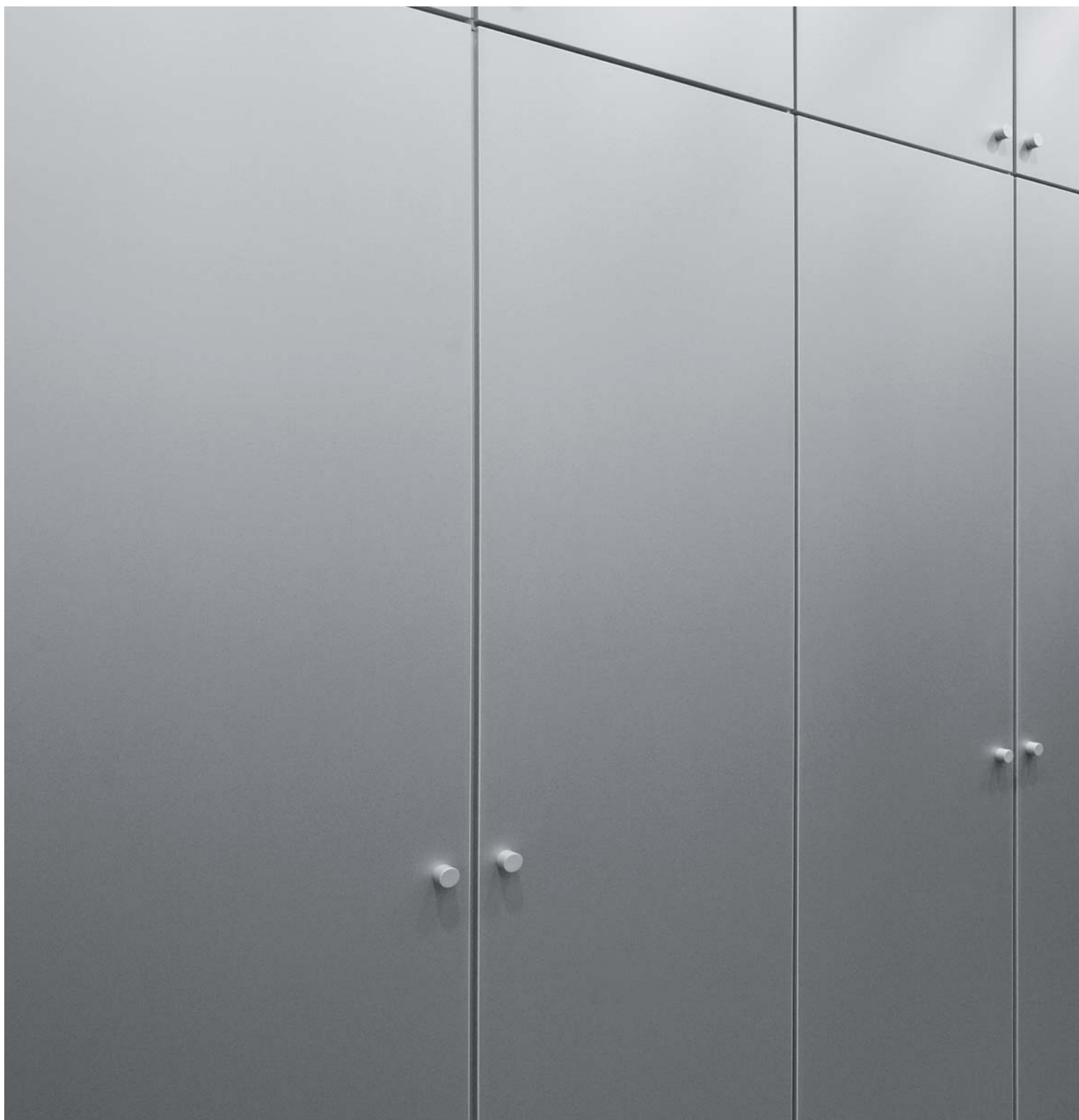

Few things last for ever: new requirements arise and we need to be able to adapt to them easily. Wall Storage is mounted and dismantled by reusable parts, catering for layout changes.

Pocas cosas son para siempre: surgen nuevas necesidades y es importante que podemos adaptarnos con facilidad a ellas. El Tabique Armario se monta y desmonta por elementos reutilizables, posibilitando los cambios de distribución.

Es gibt nur ganz wenige Dinge, die sich im Wandel der Zeit nicht verändern. Immer wieder ergeben sich neue Bedürfnisse, und sich problemlos daran anzupassen, ist eine wichtige Voraussetzung für den Erfolg. Die Trennwand mit Schrank setzt sich aus wieder verwendbaren Elementen zusammen, die montiert und zerlegt werden können und damit eine vielseitige Gestaltung mit zahlreichen Kombinationsmöglichkeiten ermöglichen.



●

INTEGRATED WALL STORAGE

In order to provide storage capacity without affecting the passage of light, our Wall Storage can be integrated into a Dynamobel glazed partition via a system based on the use of complementary profiles and fittings.

Integrated Wall Storage can also include a levelling system at the top which sets and stabilises the partition panes.



Wall Storage integrated with profiling.

Tabique Armario integrado con perfilería. Integrierte Trennwand mit Schrank und Profilen.

●●

TABIQUE ARMARIO INTEGRADO

Con el objetivo de aportar capacidad de almacenamiento sin detener el paso de la luz, el Tabique Armario se puede integrar en una partición vidriera de Dynamobel mediante soluciones ideadas en base a la utilización de perfiles y accesorios complementarios.

También es posible integrar el Tabique Armario incluyendo en la parte superior del Armario un sistema de nivelación que ajusta y estabiliza los vidrios de la partición.



Wall Storage with hidden profiling.

Tabique Armario con perfilería oculta. Trennwand mit Schrank und verborgenen Profilen.

●●●

INTEGRIERTE TRENNWAND MIT SCHRANK

Erweiterte Lagerkapazität und Lichtdurchlässigkeit stehen nicht mehr im Widerspruch. Denn die Trennwand mit Schrank kann dank der Verwendung von Profilen und Zusatzelementen problemlos in das Glastrennwandsystem von Dynamobel integriert werden.

Die Integration der Trennwand mit Schrank ist auch mit Hilfe eines Ausgleichssystems möglich, das die Glaselemente der Trennwand einpasst und stabilisiert.



Wall Storage integrated without profiling.

Tabique Armario integrado sin perfilería. Integrierte Trennwand mit Schrank ohne Profile.



▼ **Wall Storage
integrated with profiling.**
Tabique Armario
integrado con perfiles.
Integrierte Trennwand
mit Schrank und Profilen .



COATINGS

REVESTIMIENTOS • VERKLEIDUNGEN

LACQUERED
LACADOS
LACKIERUNGEN

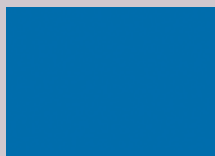

AK Electric blue
Azul eléctrico



HD Mustard yellow
Amarillo mostaza

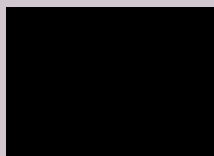

NE Black
Negro

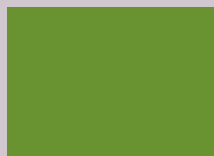

VV Spring green
Verde primavera



CV Bright red
Rojo vivo

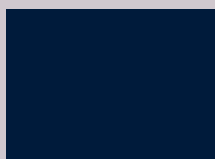

AJ Navy blue
Azul marino



BG Chocolate
Chocolate

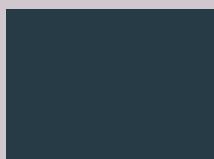

GF Deep grey
Gris profundo

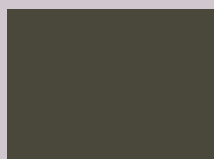

GV Greenish grey
Gris verdoso



CG Burgundy
Granate



AG Storm blue
Azul roto

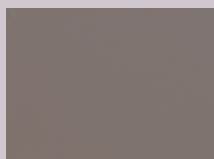

BT Mocha brown
Tostado

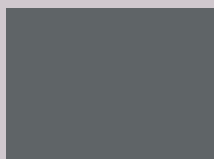

GA Anthracite grey
Gris antracita



VT Laurel green
Verde laurel



RO Red
Rojo



AF Ice blue
Azul gélido



BE Smoke
Humo

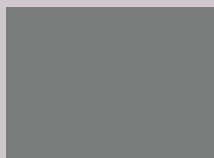

GE Mouse grey
Gris ratón



VG Khaki green
Verde caqui



CD Orange
Naranja



AE Grey blue
Azul grisáceo



BD Stone
Piedra

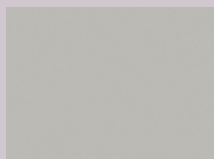

GC Light grey
Gris claro



VP Pistachio green
Verde pistacho



CC Vanilla
Vainilla

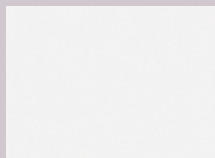

BA White
Blanco

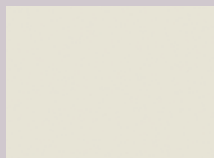

BC Cream white
Blanco crema

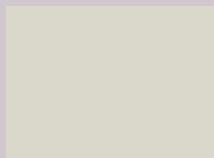

GD Off white
Blanco sucio

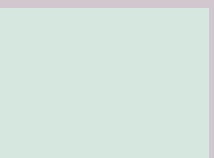

VA Sea blue
Aquamarina



CB Faded white
Blanco roto

WOOD
MADERA
ECHTHOLZ



RB White oak
Roble blanco



MB White s.g.
Mallada blanca

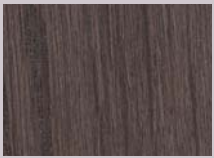

RG Grey oak
Roble gris



MG Grey s.g.
Mallada gris



RS Black oak
Roble negro

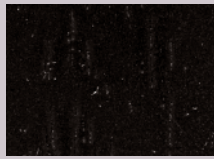

MS Black s.g.
Mallada negra



RC Cream oak
Roble crema



MC Cream s.g.
Mallada crema

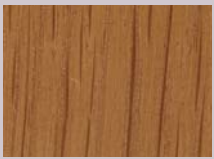

RD Honey oak
Roble miel

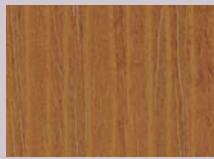

MD Honey s.g.
Mallada miel



RP Brown oak
Roble marrón

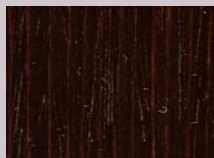

MP Brown s.g.
Mallada marrón

VINYL
VINILO
VINYL

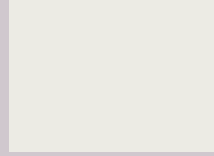

BA White
Blanco



02 Movinord white
Blanco Movinord



01 Cream
Crema



03 Sandstone
Arenisca



05 Moon grey
Gris luna



43 Aluminium
Aluminium



06 Blue
Azul



27 Beech
Haya



34 Maple
Maple



35 Decapé
Decapé



26 Cherry
Cerezo

STRUCTURE

ESTRUCTURA • STRUKTUR

POLYESTER PLAIN EPOXY
PINTURA EPOXY POLIESTER
EPOXY-POLYESTER-FARBE



AK Electric blue
Azul electrico



HD Mustard yellow
Amarillo mostaza



NE Black
Negro



VV Spring green
Verde primavera



CV Bright red
Rojo vivo

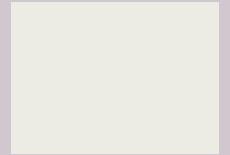

02 Movinord white
Blanco Movinord

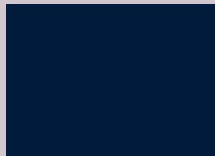

AJ Navy blue
Azul marino



BG Chocolate
Chocolate

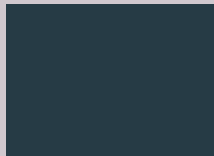

GF Deep grey
Gris profundo

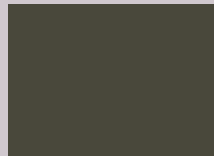

GV Greenish grey
Gris verdoso



CG Burgundy
Granate

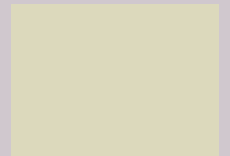

01 Cream
Crema



AG Storm blue
Azul roto

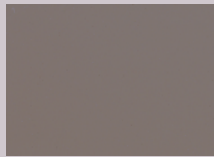

BT Mocha brown
Tostado



GA Anthracite grey
Gris antracita



VT Laurel green
Verde laurel



RO Red
Rojo



03 Sandstone
Arenisca



AF Ice blue
Azul gélido



BE Smoke
Humo



GE Mouse grey
Gris ratón



VG Khaki green
Verde caqui

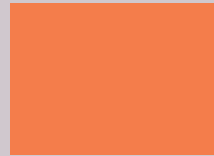

CD Orange
Naranja



05 Moon grey
Gris luna

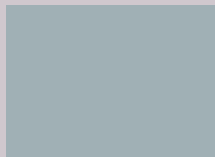

AE Grey blue
Azul grisáceo



BD Stone
Piedra

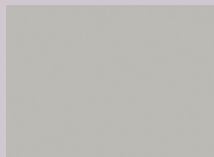

GC Light grey
Gris claro

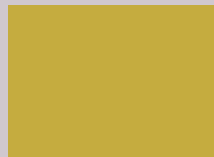

VP Pistachio green
Verde pistacho



CC Vanilla
Vainilla



06 Blue
Azul

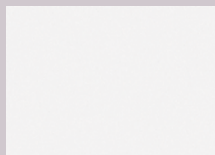

BA White
Blanco

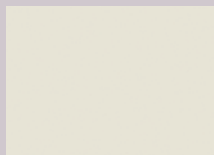

BC Cream white
Blanco crema

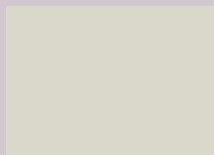

GD Off white
Blanco sucio

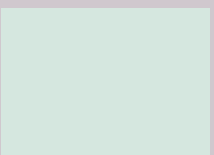

VA Sea blue
Aquamarina



CB Faded white
Blanco roto



29 Mica grey
Gris mica



04 Marengo
Marengo

METALLIE EPOXY
PINTURA METALIZADA
METALLLACKIERUNG



GP Platinum grey
Gris platino



GG Graphite grey
Gris grafito



WALL STORAGE

CHARACTERISTICS • CARACTERÍSTICAS • EIGENSCHAFTEN

Dimensions

- Standard module width between axes: 600 and 1,200 mm. Corner unit: 800 x 800 mm.
- Standard heights
 - worktop height: 882 mm
 - door height: 2,082 mm
 - floor/ceiling heights: 2,700 and 3,100 mm
- Module depths:
 - without back: 419 mm
 - with hidden back: 432 mm
 - with visible back: 438 mm
- Tolerance absorption capacity
 - on height: ±20 mm
 - on starts: <605 mm

Outer faces:

- Particle-board panels, PVC-edged, rigid or flexible, depending on requirements, and laminated with semi-rigid vinyl coatings, cellulose- or cotton-based vinyls, stratified, fine hardwoods, etc. to choose from the Dynamobel finish range. System 32 machining and levellers integrated. Total thickness depending on components: 13, 16, 19 or 30 mm.
- Shelves:
 - Particle board: 600 mm wide and 19 mm thick, edged as on rest of design with 2-mm thick edging.
 - Steel: 600 or 1200 mm-wide steel plate. Colour to choose.
- Option: filing-drawer support.
 - Particle board for bookshelf modules: 600 and 1200 mm wide and 30 mm thick.
- Blind, flat door leaves in particle board, edged and with the same surface finish options as panels, or glazed with aluminium frame. Total thickness: 19 mm.
- Glazed options for bookshelf modules.

Frame

- Telescopic bottom runner and top runner in Sendzimir galvanised steel.
- Quality in accordance with European standard EN 10142-A1:1994 (DX51D+Z).

Paintwork

- Previously degreased.
- Electrostatically coated with polyester powder or polyester epoxy paint and polymerised at 200°C.
- Average paint coat thickness: 50/60 µ.
- Colour tolerance: standard DIN 5003.

Fittings

- Demountable, triple-position hinges in same nickel plate finish as shelf supports. Other fittings in paint, zinc, anodised finish, etc. as required.
- Telescopic file drawers and drawers. Measurements 600 and 1200 mm.

Demountability and re-installation

- Complete, independent demountability of all modules thanks to independent assembly and fixture systems for each structural element.
- Total module and component re-installation and interchangeability.

Dimensiones

- Modulaci3n horizontal entre ejes estandar : 600 y 1.200 mm y esquinero de 800 x 800 mm.
- Alturas estandar
 - altura mostrador: 882 mm
 - altura puerta: 2.082 mm
 - altura suelo / techo: 2.700 y 3.100 mm
- Profundidad de m3dulos:
 - sin trasera: 419 mm
 - con trasera oculta: 432 mm
 - con trasera vista: 438 mm
- Capacidad de absorci3n de tolerancia
 - en altura: ±20 mm
 - en arranques: <605 mm

Paramentos exteriores:

- Tableros aglomerados de partculas de madera, canteados con PVC, r3gidos o flexibles segun necesidades y aplacados con revestimientos vinilicos semi-r3gidos, vinilos con soporte celul3sico o de algod3n, estratificados, maderas nobles, etc. a elegir dentro de la colecci3n de acabados Dynamobel. Los mecanizados sistema 32 y niveladores est3n integrados. Espesor total segun elementos: 13, 16, 19 o 30 mm.
- Baldas:
 - En tablero de aglomerado: de 600 mm de ancho y 19 mm de espesor canteado a juego con canto de 2 mm de espesor.
 - En chapa de acero: 600 o 1.200 mm de ancho de chapa de acero, con color a elegir. Posibilidad de soporte carpetero.
 - En tablero de aglomerado para m3dulos de librer3a: 600 y 1.200 mm de ancho y 30 mm de espesor.
- Hojas de puerta, planas y ciegas en aglomerado de partculas de madera, canteadas y con las mismas posibilidades de revestimiento que los tableros; o de vidrio con marco de aluminio. Espesor total 19 mm. Opciones de vidrio para m3dulos librer3a.

Estructura

- Rodapi3 telesc3pico y coronaci3n en acero galvanizado Sendzimir.
- Calidad segun norma europea EN 10142-A1:1994 (DX51D+Z).

Pintura

- Tratamiento previo de desengrase.
- Aplicaci3n electrost3tica de pintura en polvo poliester o epoxi-poliester y polimerizado en horno a 200° C.
- Espesor medio de capa de pintura: 50/60 µ.
- Tolerancia en colorido: norma DIN 5003.

Accesorios

- Bisagras desmontables de triple regulaci3n, en acabado niquelado al igual que los soportes de baldas y resto de accesorios con recubrimiento de pintura, cincado, anodizado, etc. segun necesidad.
- Carpeteros y cajones extraibles telesc3picamente. Medidas de 600 y 1.200 mm.

Desmontabilidad y reinstalaci3n

- Desmontabilidad completa e independiente de todos los m3dulos por la incorporaci3n de sistemas de ensamblaje y fijaci3n independiente de todos los elementos de la estructura.
- Reinstalaci3n e intercambiabilidad total de m3dulos y elementos.

Abmessungen

- Modulbreite zwischen Standardachsen: 600 mm und 1.200 mm und Eckelement 800 mm x 800 mm.
- Standardh3hen
 - Thekenh3he: 882 mm
 - T3rhh3he: 2.082 mm
 - H3he vom Boden bis zur Decke: 2.700 mm und 3.100 mm
- Tiefe der Module:
 - ohne R3ckwand: 419 mm
 - nicht sichtbare R3ckwand: 432 mm
 - sichtbare R3ckwand: 438 mm
- Ausgleichspotential
 - vertikal: ±20 mm
 - bei Anfangselementen: <605 mm

Au3enfl3chen:

- Pressplatte, Kantenbes3umung aus PVC, starr oder elastisch je nach Anforderung, und Beschichtung aus halbstarrem Vinyl, Vinyl mit einer Tr3gerschicht aus Zellulose oder Baumwolle, Laminat, edle H3lzer usw., die aus den Oberfl3chen der Dynamobel-Kollektion ausgew3hlt werden k3nnen. Die mechanisierten Teile des Systems 32 und die NivellierVorrichtungen sind integriert. Gesamtdicke je nach Elementen: 13, 16, 19 oder 30 mm.
- Fachb3den:
 - Aus Pressplatten: 600 mm breit, mit einer Dicke von 19 mm und Kantenbes3umung passend zu Kante mit 2 mm Dicke.
 - Aus Stahlblech: 600 oder 1.200 mm Breite aus Stahlblech, Farbe frei w3hlbar. M3glichkeit zur Befestigung von H3ngemappenausz3gen.
 - Aus Pressplatten f3r B3cherschrankmodule: mit einer Breite von 600 und 1.200 mm und einer Dicke von 30 mm.
- Flache T3rbl3tter, in nicht transparenter Ausf3hrung aus Pressholzplatten, mit Kantenbes3umung und mit den gleichen Optionen f3r die Verkleidung wie bei den Paneelen; oder aus Glas mit Aluminiumrahmen. Gesamtdicke 19 mm. Glasoptionen f3r B3cherschrankmodule.

Aufbau

- Teleskop-Fu3lleiste und Krone aus Sendzimir-verzinktem Stahl.
- Qualit3t nach europ3ischer Norm EN 10142-A1:1994 (DX51D+Z).

Lackierung

- Vorbehandlung zur Entfettung.
- Elektrostatische Pulverbeschichtung mit Polyester oder Epoxy mit nachfolgender Einbrennung im Ofen bei 200° C.
- Mittlere Dicke der Farbschicht: 50/60 µ.
- Farbtoleranzen: gem33 DIN-Norm 5003.

Zubeh3r

- Abnehmbare Scharniere, dreifach verstellbar, in vernickelter Ausf3hrung, ebenso wie die Aufnahmen der Fachb3den sowie sonstiges Metallzubeh3r, mit Lackierung, Verzinkung, Eloxierung usw. behandelt, je nach Bed3rfnis.
- H3ngemappenausz3ge und Schubladen mit Teleskopauszug. Ma3e 600 mm und 1.200 mm.

Abbau und Wiedereinbau

- Komplette und unabh3ngige Abbaubarkeit aller Module dank der Ausstattung mit unabh3ngigen Montage- und Befestigungssystemen an allen Elementen der Struktur.
- Wiedereinbau und vollst3ndige Austauschbarkeit der Module und Elemente.

WALL STORAGE

HORIZONTAL SECTIONS • SECCIONES HORIZONTALES • HORIZONTALSCHNITTE

WITH VISIBLE BACK
CON TRASERA VISTA
MIT SICHTBARER RÜCKWAND

Modules · Módulos · Module

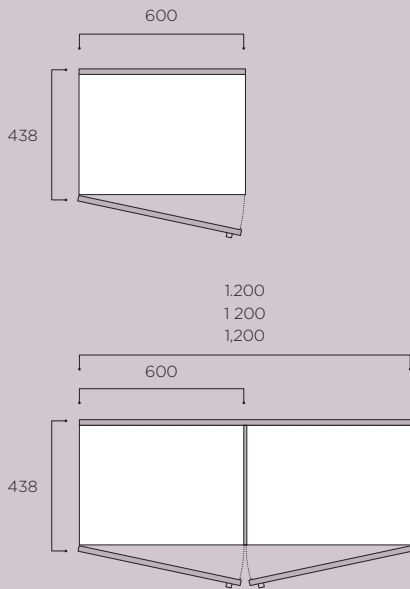

Wall start · Arranque pared · Wandverbindung

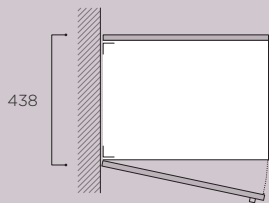

Terminal · Remate frontal · Vorderes Abschlussstück

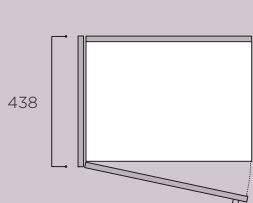

Corner module · Módulo esquinero · Eckmodul

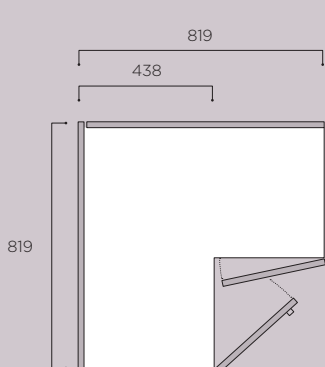

WITH HIDDEN BACK
CON TRASERA OCULTA
MIT NICHT SICHTBARER RÜCKWAND

Modules · Módulos · Module

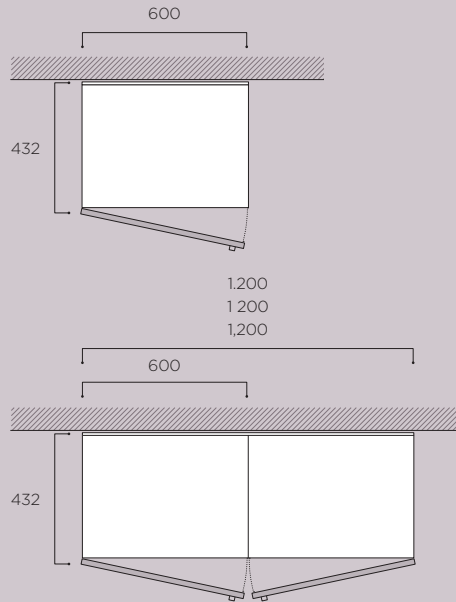

Wall start · Arranque pared · Wandverbindung

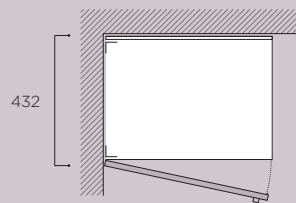

Terminal · Remate frontal · Vorderes Abschlussstück

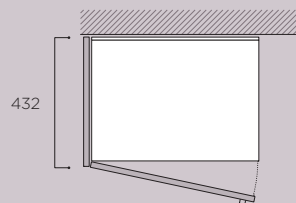

Corner module · Módulo esquinero · Eckmodul

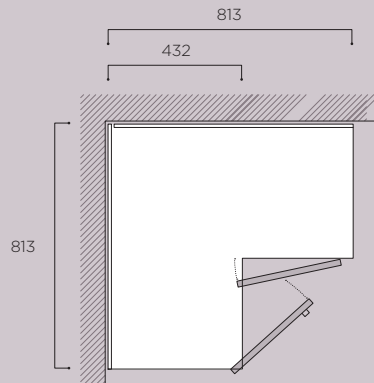

WITHOUT BACK
SIN TRASERA
OHNE RÜCKWAND

Modules · Módulos · Module

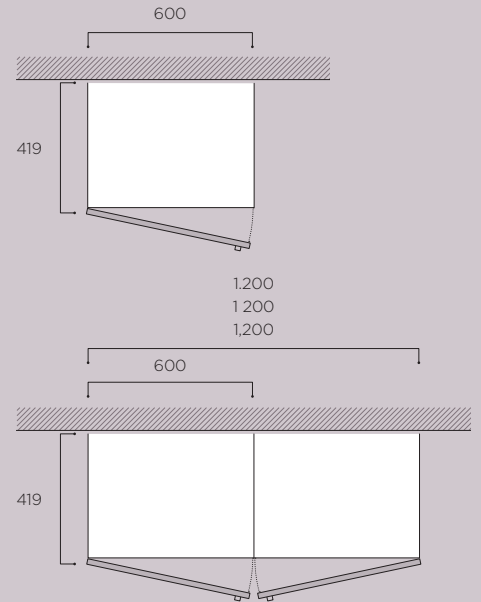

Wall start · Arranque pared · Wandverbindung

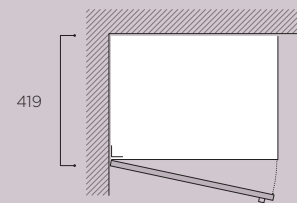

Terminal · Remate frontal · Vorderes Abschlussstück

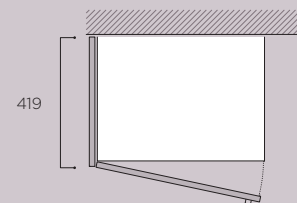

Corner module · Módulo esquinero · Eckmodul

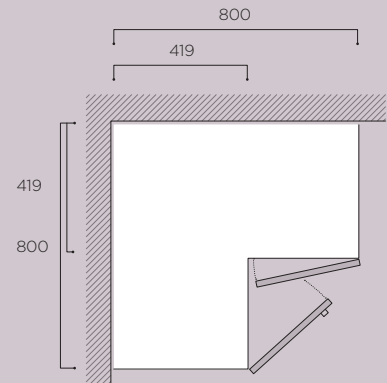

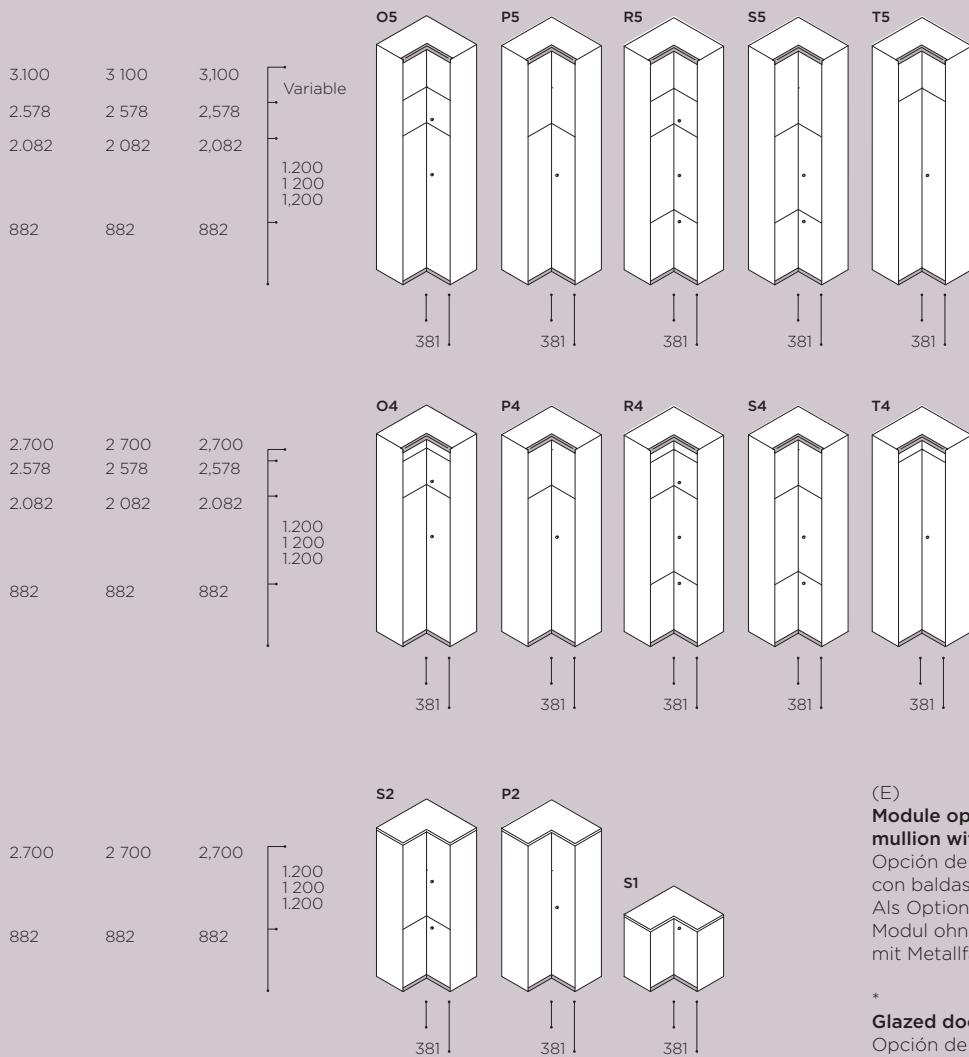

INTEGRATED IN PARTITION • INTEGRADOS EN PARTICIÓN • IN DIE TRENNWAND INTEGRIERT

Assembly 1. Wall start.
Conjunto 1. Arranque pared.
Teilesatz 1: Wandverbindung.

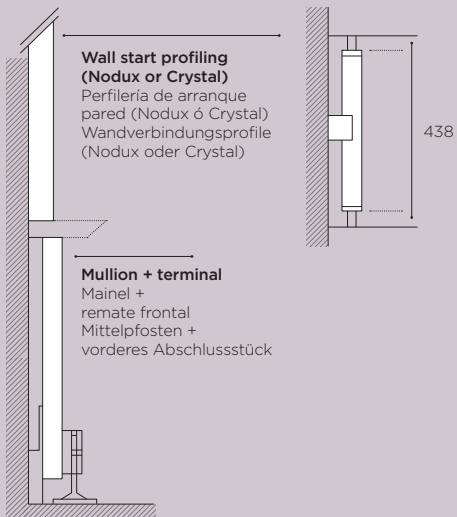

Assembly 3. Module join.
Conjunto 3. Unión módulos.
Teilesatz 3: Modulverbindung.

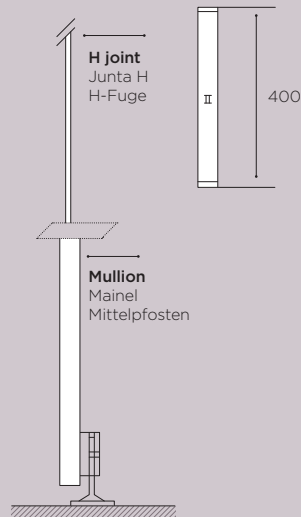

Assembly 5. Terminal.
Conjunto 5. Remate frontal.
Teilesatz 5: vorderes Abschlussstück.

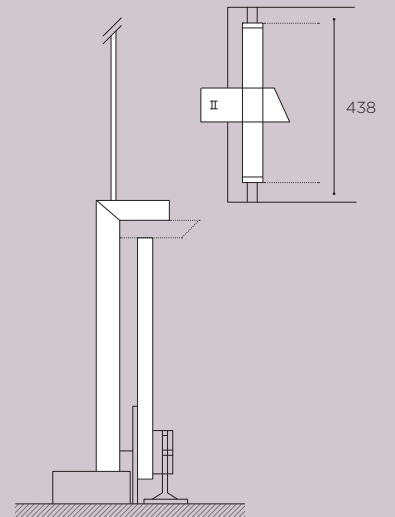

Dynamobel S.A.

CENTRAL INBOX, SPAIN

Ctra. Madrid Km 24
31350 Peralta
Navarra, Spain
T +34 948 750 000
F +34 948 750 750
info@dynamobel.com

CENTRAL BOX, SPAIN

Ctra. de Guipúzcoa Km 7,5
Apdo. 1074 31080 Pamplona
Navarra, Spain
T +34 948 303 171
F +34 948 302 581
info@dynamobel.com

DESIGN ALDRICH
PHOTOGRAPHY LUIS PRIETO,
MARTIN&ZENTOL, ALFONSO PERKAZ

KJM/CAT/047/11

© DYNAMOBEL. ALL RIGHTS RESERVED.
REPRODUCTION OF THE WHOLE OR ANY PART
OF THE CONTENTS IS PROHIBITED.

We are breaking out of the rigid structure through which many companies in the sector impose standard solutions without questioning the constraints these place on good ideas.

Our aim is to venture beyond, stay one step ahead, because we believe that good ideas deserve more than a simple, all-embracing solution.

We work to understand designers and look into ways of solving their work, providing a suitable balance between customisation and industrialisation. Good ideas do not compromise form or function. We will defend that come what may.

Nos salimos de la estructura rígida de muchas empresas del sector en el que se imponen soluciones estándar sin cuestionarse las limitaciones que éstas imponen en las buenas ideas.

Nuestro propósito es ir más allá, un paso por delante, porque creemos que las buenas ideas merecen más que una solución masiva.

Trabajamos por entender a los creadores y explorar formas de resolver sus obras, que ofrezcan un adecuado equilibrio entre personalización e industrialización. Las buenas ideas no comprometen forma ni función. Defenderemos esto ante todo.

Wir haben uns von den starren Strukturen gelöst, in denen viele Unternehmen des Sektors verharren, indem sie Standardlösungen bieten, ohne sich dabei die Frage zu stellen, in welchem Maße diese die Umsetzung guter Ideen einschränken.

Wir haben es uns zum Ziel gesetzt, weiter zu denken und immer einen Schritt voraus zu sein, denn wir sind überzeugt, dass eine gute Idee mehr verdient als einfach nur eine vorgefertigte Lösung.

Wir bemühen uns, die Menschen, die Ideen entwickeln, zu verstehen, und versuchen, Mittel und Wege zu finden, um diese Ideen zu verwirklichen, ohne dabei jedoch ein angemessenes Gleichgewicht zwischen Individualität und Standardisierung aus dem Auge zu verlieren. Gute Ideen beeinträchtigen weder Form noch Funktion. Diesen Standpunkt vertreten wir mit allem Nachdruck.

